

Kentucky Wood Ducks



Kentucky Department of Fish and Wildlife Resources



Kentucky Department of Fish & Wildlife Resources
#1 Sportsman's Lane, Frankfort, KY 40601
1-800-858-1549 • fw.ky.gov



Kentucky Wood Ducks

Written by Russ Kennedy

Edited by Ronald D. Pritchert

Illustrations and design by Adrienne Yancy

December 2008

Material for this booklet was compiled from U.S. Geological Survey and U.S. Fish & Wildlife Service publications as well as from the Kentucky Breeding Bird Atlas (Palmer-Ball Jr., 1996).

Cover photo courtesy of the U.S. Fish & Wildlife Service.



U.S. Fish & Wildlife Service photo

Kentucky Wood Ducks

Many regard the wood duck (*Aix sponsa*) as North America's most beautiful waterfowl species. Distinguished by their colorful plumage – the scientific name means “waterbird in bridal dress” – woodies, as they are commonly called, are medium-sized ducks, usually weighing around 1 ½ pounds. A typical adult wood duck is 17-20 inches long and has a 30-inch wingspan. Their broad, relatively short wings aid acrobatic flight through thick woods and other tight cover.

Actually, it's the male wood duck that sports the vivid maroon, white, blue, green, red and black plumage. The female's grayish-brown coloration might be considered quite bland in comparison to her male counterpart. Her 'earthtones' provide an important ground camouflage function during the brood-rearing period.

John James Audubon (1861) labeled wood ducks “abundant” in western Kentucky in the early 1800's. However, widespread clearing and draining of their wooded wetland habitat in the Mississippi River floodplain led to sharp population declines.

At one time plentiful throughout their natural range (Fig. 1), wood duck numbers plummeted to alarming lows in the mid-late 19th century. By the early 1900's, wood ducks had all but disappeared from North America, the victims of habitat destruction and unregulated hunting.

Today, thanks to scientific wildlife management and modern conservation practices, wood ducks are abundant across their natural range. Hunting is again permitted in Kentucky and throughout North America. Wood ducks are important to Kentucky waterfowling and in many years is the second most common duck harvested.

The Kentucky Department of Fish and Wildlife Resources (KDFWR) annually conducts more than two dozen intensive wood duck brood surveys statewide. And while woodies are recorded on nearly every stream throughout the Commonwealth, they are most abundant in the floodplain sloughs, swamps and wooded wetlands of western Kentucky.

The modern-day construction of large reservoirs and farm ponds has, in many instances, created suitable wood duck habitat and bolstered populations in many areas including central and eastern Kentucky. An aggressive program to provide artificial (wooden) nest boxes also has had a positive population effect.

Habitat

Wood ducks thrive in woodland areas along streams, rivers, lakes and vegetated freshwater wetland areas. Bottomland hardwood wetlands, beaver ponds, oxbows, meanders and backwaters are preferred habitat types. Preservation and management of old growth timber along river corridors produces especially high-quality wood duck habitat.

Woodies feed primarily in shallow-water areas on aquatic plants and

Figure 1. Distribution and breeding range of the wood duck. Map based on Cornell Lab of Ornithology data.



seeds, insects and invertebrates. They also forage on the forest floor for acorns, nuts and seeds. Aquatic insects and invertebrates are particularly important for adult hens during spring nesting activities. Acorns, hickory nuts and other forest mast are most important as fall and winter foods, as are the seeds of cypress, sweet gum and buttonbush.

Habitat components must be available in relative close proximity to one another for wood duck reproduction and survival to occur. The highest-quality nesting habitat is of little consequence if the nearest brood-rearing habitat is more than a mile away. Similarly, good brood-rearing habitat is useless in the absence of nearby nesting habitat.

Prime wood duck habitat is also attractive to other waterfowl species including mallards, black ducks, hooded mergansers and ring-necked ducks.

Migration

Wood ducks are a ‘migratory’ species. While a few stay in Kentucky throughout the year, most move south (i.e. migrate) toward the Gulf of Mexico when cooler fall weather invades the Commonwealth.

Wood ducks migrate in pairs or small flocks and return in late February to mid-March to begin springtime nesting activities.

Interestingly enough, Kentucky’s fall and winter wood ducks (those we encounter during the traditional hunting seasons) are usually visitors from other states to the north. When colder temperatures signal Kentucky’s resident woodies that it’s time to journey south, the arrival of brisk winds, colder temperatures and snow in the more northern states sends a similar “time-to-head-for-warmer-climes” message to migratory waterfowl in higher latitudes.

When winter begins to fade and spring arrives, “resident” woodies that have wintered to the south return home to Kentucky, while birds that have wintered here return to their more northern ranges.

Reproduction

Wood ducks nest in natural tree cavities and in some cases, openings created and abandoned by woodpeckers. In the absence of natural cavities, man-made nesting boxes are readily accepted, when built to prescribed dimensions. (Wood duck nest boxes are discussed in detail elsewhere in this booklet.)

The average clutch size for wood ducks is 10-15 dull white eggs, however nests have been found to contain 30 or more. The hen usually lays one egg daily until her job has been completed.



Wood duck hens will readily accept man-made nest boxes.

Photo © Maslowski Wildlife Productions

The month-long incubation period begins after the last egg is laid. While broods of young birds usually start appearing around the first of May through early June, the peak of the hatch occurs from mid-May to mid-June. In some years the hatch extends through early July.

Hatchlings usually leave their nest after just 24 hours. The mother hen stays with her brood until they can fly, typically 8-10 weeks.

'Egg dumping' (i.e., intraspecific brood parasitism) occurs when a female wood duck, usually a first-year breeder, follows another hen to her nest site and subsequently utilizes it. Dumping most often happens when suitable nesting sites are in short supply or when nest boxes are clumped together.

Except in egg-dumping situations, approximately 80 percent of wood duck eggs will hatch. Hatch rates can drop as low as 10 percent in a dump nest.

Unfortunately, low survival rates are common among waterfowl species. Up to 90 percent of newly hatched wood ducklings will die in their first two weeks – only a 10 percent survival rate. As the wood duck's 90 percent early mortality rate is higher than for many prairie ducks, nature compensates for that disparity with increased clutch size and a vigorous re-nesting drive. The survival rate improves to 50 percent among birds that survive those first 14-15 days.

Management

Wood ducks respond well to habitat protection and enhancement, meaning that landowners and habitat managers can assist in the continued success of wood ducks and other migratory waterfowl species that rely on similar aquatic habitat.

Often considered nuisances, beaver ponds can provide excellent wood

duck habitat and should be left undisturbed whenever possible.

As with many wildlife species, the greatest threat to wood ducks is the continued loss of habitat. By protecting and restoring floodplain timber, river oxbows and meanders, and other freshwater and riparian habitats, we can help insure the future for wood ducks.

Guided by the principles of scientific wildlife management, reservoir and pond construction, wetland habitat reclamation and development, and conservative harvest limits have contributed greatly to the wood duck's population resurgence.

Private Land Management

Man-made shallow-water impoundments can provide excellent habitat for wood ducks and other migratory waterfowl. These impoundments catch and hold rain and runoff behind levees (earthen dams).

It is important to distinguish between duck-friendly, shallow-water impoundments and farm or fish ponds. A farm/fish pond doesn't necessarily provide favorable duck habitat.

Typical farm pond features include an average depth of three or more feet, steeply sloping sides, brush-free banks, and smooth, bulldozed bottoms. Ponds built for ducks are not more than a couple of feet deep at most (an average depth of 12-18 inches is ideal!) and offer gently sloping banks so ducks can easily walk up on shore.

A duck pond might also provide a couple of small islands for ground-nesting waterfowl. As noted, woodies are cavity nesters, but other desirable waterfowl like mallards and Canada geese will also be attracted to the duck pond and will nest on the islands.

It is possible, given proper slope, to build a farm/fish pond that also provides suitable duck habitat (Fig. 2). The slope must be such that deeper water can collect at the levee end while only very shallow water (12-18

Figure 2. Duck-friendly farm pond.

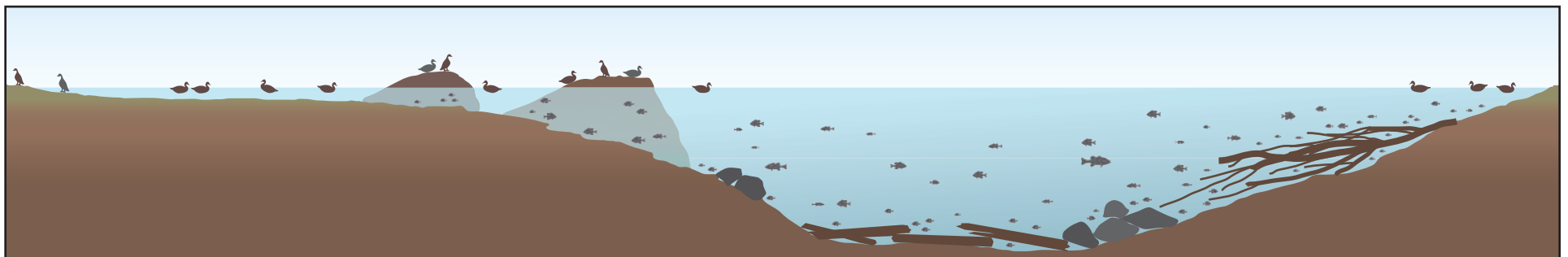

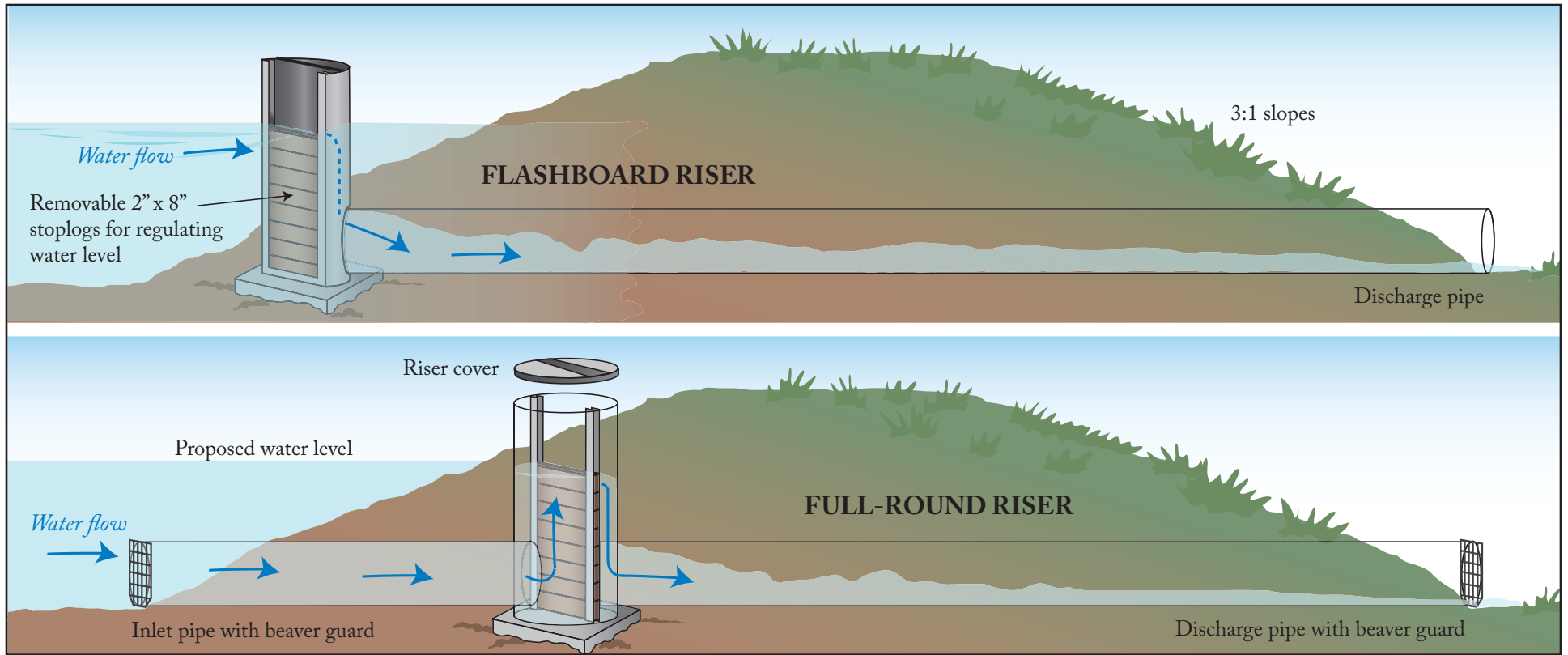

Figure 3. Sample water control structures. For more information on these and other such structures see www.southern.ducks.org/WaterControlStructures.php.

inch depths) collects at the opposite end.

A convenient drainage system will allow for late spring draining so marshy vegetation that will provide next year's food and cover can sprout and take hold on the pond's bottom and banks during the growing season. Seeds from annual plants that thrive in wet areas remain viable for years and will germinate in moist, exposed soil.

A water-control structure (WCS) installed in the levee (Fig. 3) during construction will provide a landowner or habitat manager the ability to manipulate the water level in a shallow-water impoundment, often called a moist-soil unit (MSU). In late fall, the WCS can be closed to trap and hold rain and runoff. The structure allows for the gradual build-up of water so as the moist-soil vegetation that has come in over the summer growing season is "used up" (consumed), the water's surface area can be expanded to cover unused aquatic plants along new edges.

A landowner-assistance program called Kentucky Partners for Wetland Wildlife (KPWW), offered jointly by KDFWR, Ducks

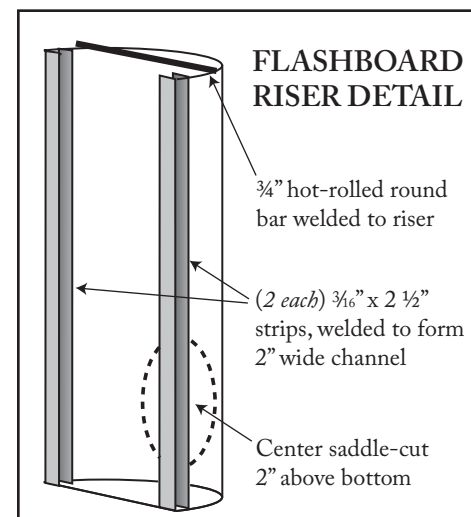

Unlimited, Inc., the U.S. Fish & Wildlife Service and the U.S. Department of Agriculture (USDA)'s Natural Resources Conservation Service (NRCS), provides free water-control structures for approved habitat-development projects. Read more about KPWW elsewhere in this publication, or go online: fw.ky.gov. From the home page, click on Wildlife, then on Programs.

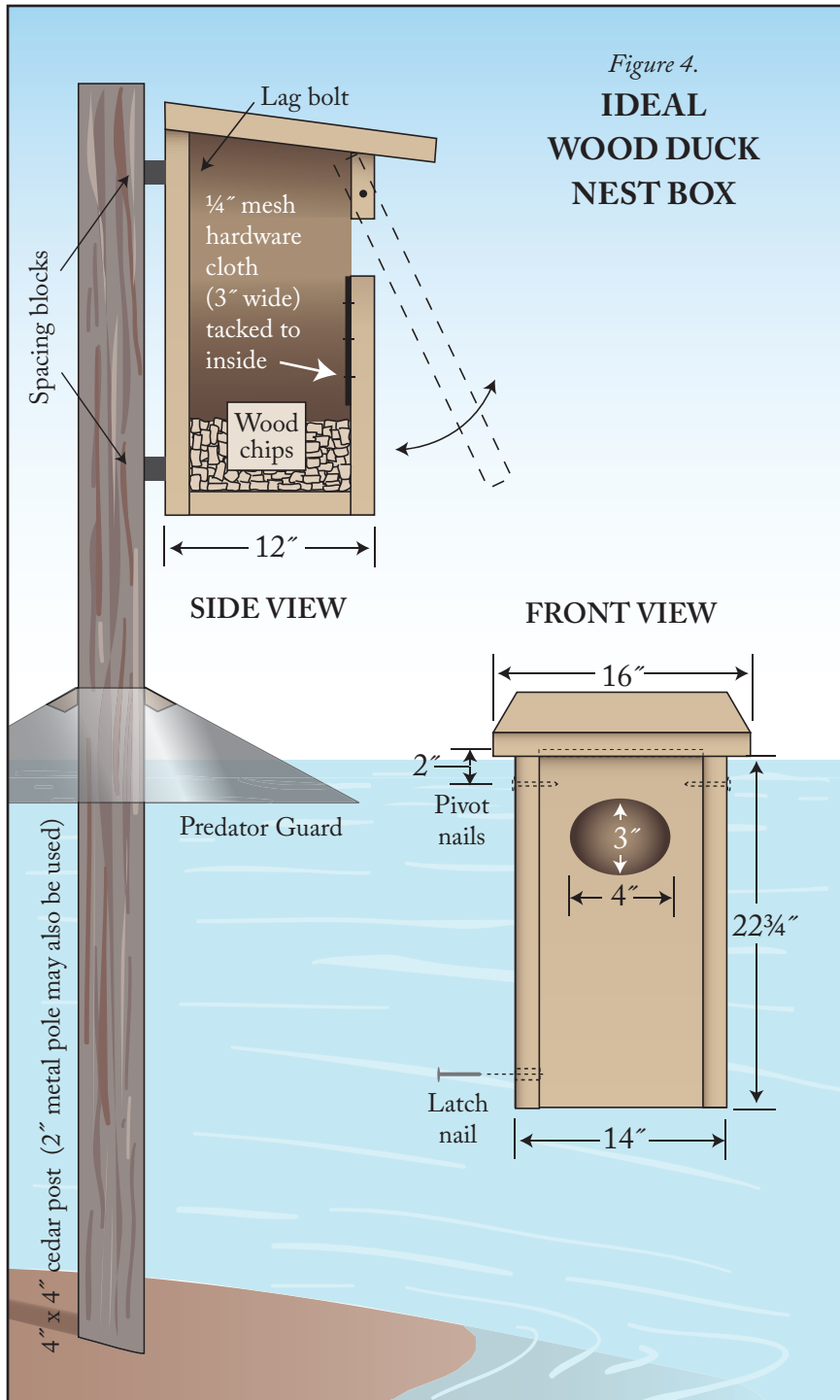

Nest Boxes for Wood Ducks

Building and installing nest boxes can provide much fun and enjoyment for the landowner and serves an important function for wood ducks.

Nest boxes should be constructed of a weather-resistant wood; cypress is an excellent choice and oak works well. Never use treated lumber! (Treatment chemicals kill embryos.) Paint or stain is okay as it aids in weather protection, but should be applied only on the outside. Nest box dimensions can vary and numerous designs have proven to work well. Hole size is more important – an oval 3 inches high and 4 inches wide is preferred.

The KDFWR recommends the traditional larger-size nest boxes that are 24 inches tall (Fig. 4) with inside dimensions of 10x10 or 10x12 inches. Smaller-size boxes typically 8 inches wide, 15 inches tall and 12 inches deep have been used in recent years with some success.

Whether building a box of traditional or smaller dimensions, cut the backing board an inch or two longer than the main body of the box and drill center holes at both ends for easy wood-screw or lag-bolt installation. Also allow for an inch or so of overhang on the front and sides when cutting the top.

Install a three-inch wide piece of 1/4-inch hardware cloth (wire mesh) on the inside, under the entrance hole. The mesh works like a ladder to assist ducklings in their climb to the entrance/exit hole. Be sure to fold back cut edges to avoid injury to the hen and newly hatched birds.

A few 1/4-inch holes drilled in the bottom of the box should provide adequate drainage.

A three-inch layer of wood chips (available at your local pet store) makes excellent nesting material. Avoid straw or hay as they may be contaminated. Sawdust doesn't drain nearly as well as chips, and should be only a second choice.

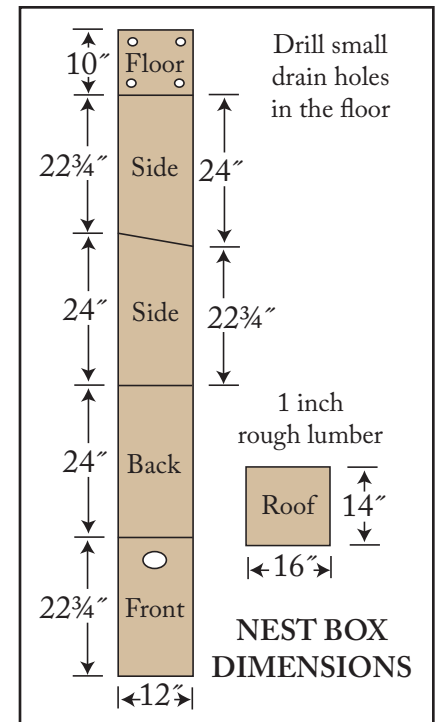



Photo © Maslowski Wildlife Productions

Install the top, one side or the front so that it can be opened for cleaning and/or monitoring.

Annual cleaning is a key element in maintaining a successful nest box and provides an opportunity to monitor usage. Replace the nesting material in the bottom of the box annually. This annual refurbishment is best performed in mid-late winter, well ahead of nesting (and nest site selection) season. A pre-February service date will assure that new nesting material remains relatively fresh and lessens the likelihood of scaring off interested wood ducks.

Nesting woodies don't bring anything to the box, so if you find other nesting materials (straw, twigs, etc.) present, a starling or some other 'competing' winged user brought them there. In the case of a dump nest, you might find abandoned, unhatched eggs. Finding shell fragments and membrane is a good indicator of a successful nest. Shell fragments *without membrane* can be the residual of an untimely predator visit.

It can take a while for woodies to adjust to the presence of nest boxes, so don't be disappointed if a newly installed unit is not used in the first available season. As a matter of fact, it can sometimes take several years for wood ducks to move in. Remember, these man-made nesting structures are a 'second choice' and will be used only when they provide the best or easiest nesting option.

Nest Box Placement

Proper placement is as important as proper construction – wood ducks like their nesting privacy. Nest boxes should be placed at least 100 yards apart and should not be visible to one another, to minimize nest dumping. Clumping or bunching of boxes is counter-productive and not recommended. Apply the "less is more" theory.

Birds hatched in nest boxes tend to choose nest boxes over natural cavities in trees when it comes time for their own nesting activities. Conversely, birds hatched in natural cavities will first search for same when they choose a nest site. Because of this 'imprinting' behavior, a successful nest box program will 'grow' a breeding flock as woodies return each year and boxes can then be added gradually over a period of time.

Nest boxes can be placed on land or over water. Ideally, your box will be in or over water and in a fairly well 'covered' area. Avoid sites in an open space. Away from water, secluded areas within timber stands offer preferred sites, but make sure the nest box faces and that there's a reasonably clear path to the water.

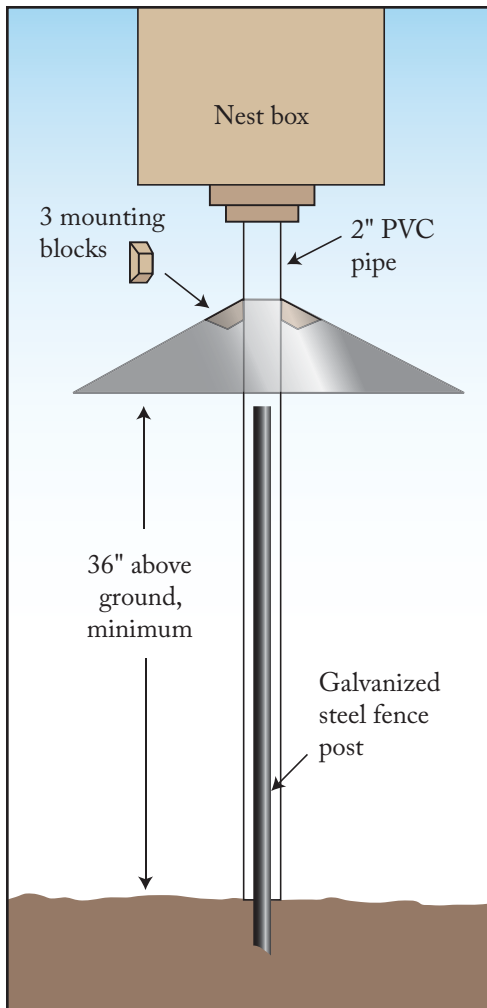

Figure 5. Predator guard.

Mount your nest box on a pressure-treated 4x4-inch post, a galvanized steel fence post or PVC pipe. In most cases, it is highly advisable to steer clear of installation directly on trees to avoid tree damage and reduce predation. A galvanized sheet metal predator guard (Fig. 5) is highly recommended and will protect the hen and her ducklings from raccoons, snakes and other predators. By its very composition, PVC pipe is too slick for predators to climb.

When setting posts, be sure that one-third is actually in the ground. For example, a 10-ft. long 4x4-in. post should be set 3-3½ ft deep into the ground leaving 6½-7 ft. exposed. Ideally, your nest box entrance/exit hole will be facing the water 5-6 ft. above the ground or water surface.

The KPWW program provides wood duck nesting

boxes, 4x4 posts and predator guards free of charge for approved projects.

A site visit by your KDFWR private land biologist (PLB) or NRCS Liaison is required and will help determine suitable spots for nest box placement as well as an appropriate number.

To learn more about KPWW, wood duck nest box boxes, or any other wildlife habitat program, speak to your nearest PLB or NRCS Liaison. Contact information is listed on KDFWR's web site: fw.ky.gov. From the home page, click on Wildlife, then on Contacts.

If you're still not sure who your PLB is, give us a call. Contact the KDFWR; phone 1-800-858-1549.

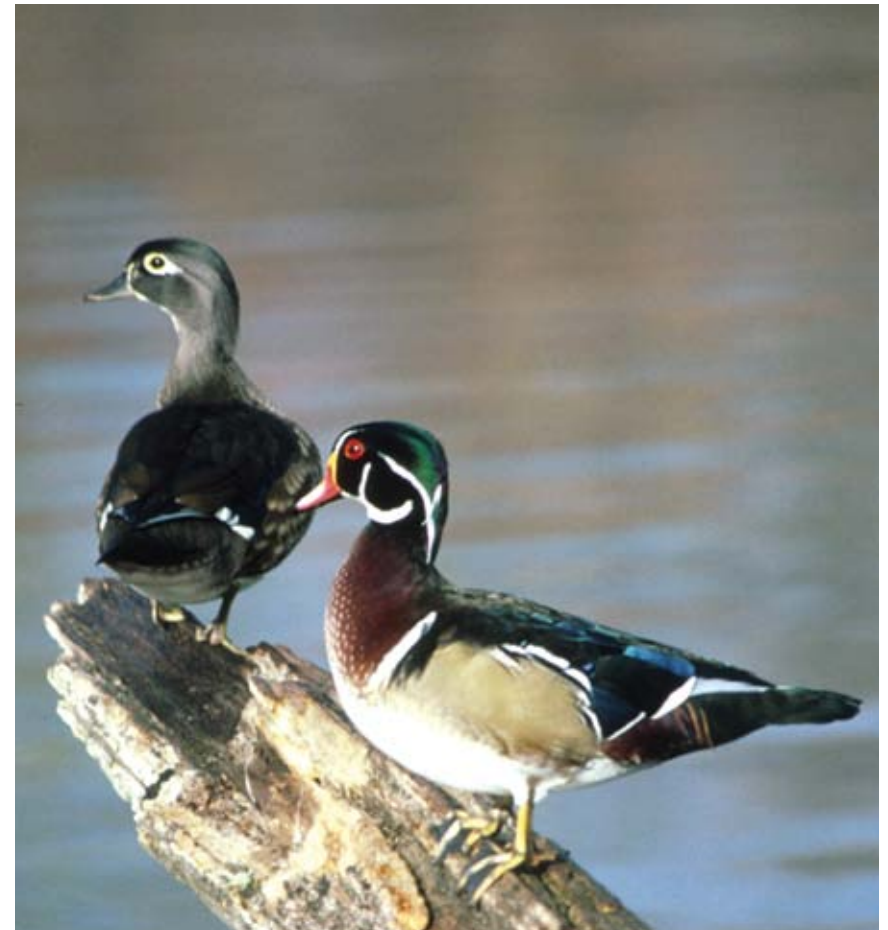

U.S. Fish & Wildlife Service photo

Wood Ducks - A Genuine Treasure

The story of the wood duck is a grand example of how active and aggressive wildlife management techniques and modern conservation practices can have a positive effect on the overall success of a particular species.

While wood duck populations have recovered dramatically, the greatest threat to their future, as with many wildlife species, is continued habitat destruction. By protecting and restoring freshwater wetland habitats, wildlife managers and private landowners can jointly assure the continued success of wood ducks and other migratory waterfowl species.



*This publication was partially funded with Federal Aid Pittman Robertson Funds (PR).
The Kentucky Department of Fish and Wildlife Resources is funded through the sale of
hunting and fishing licenses. It receives no general fund tax dollars.*

Kentucky
UNBRIDLED SPIRIT™